



0.50" Single Digit Numeric Single Color LED Display

0.50" (12.7mm) digit height

● ABSOLUTE MAXIMUM RATINGS : (Ta=25°C)

PARAMETER	RED ORANGE	GREEN	YELLOW	SR RED	SUPER RED	SUPER GREEN	SUPER YELLOW	UNIT
Power Dissipation Per Seg	65	65	55	72	65	65	55	mW
Peak Forward Current Per Seg (1/10 Duty Cycle, 0.1ms Pulse Width)	100	100	80	125	100	100	100	mA
Continuous Forward Current Per Seg Derating Linear From 25°C Per Seg	25	25	20	30	25	25	25	mA
Reverse Voltage Per Seg	5	5	5	5	5	5	5	v
Operating Tem Range	-35°C to + 85°C							
Storage Tem Range	-35°C to + 85°C							
Solder Tem 1/16 inch Below Seating Plane at 260°C for 3 seconds								

● PACKAGE DIMENSIONS

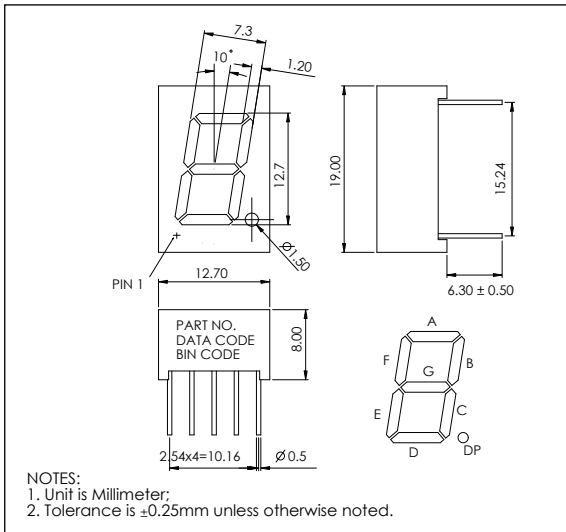

● INTERNAL CIRCUIT DIAGRAM

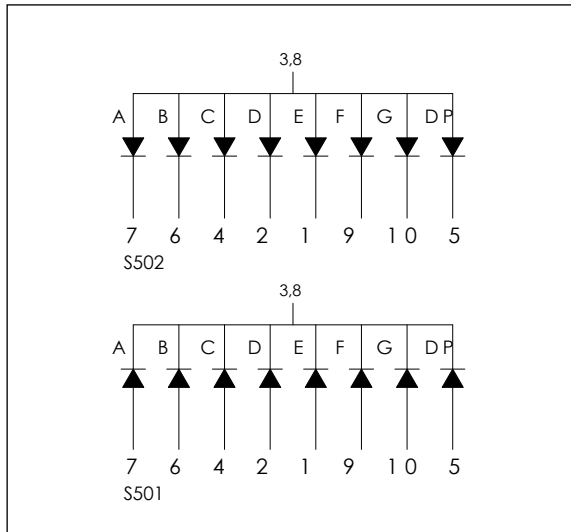

● ELECTRICAL/OPTICAL CHARACTERISTICS

PART NO.	COLOR	λ_p/λ_d (nm)	Half-Spectral Width($\Delta\lambda$)	Description	AVERAGE LUMINOUS INTENSITY			FORWARD VOLTAGE	
					Min.(mcd)	Typ.(mcd)	@ IF(mA)	Typ.(V)	@ IF(mA)
S5020E...	RED ORANGE	632/622	35	CA	1.2	3.0	10	2.0	20
S5010E...				CC					
S5020G...	GREEN	568/570	30	CA	1.6	4.0	10	2.1	20
S5010G...				CC					
S5020Y...	YELLOW	589/590	35	CA	1.2	3.0	10	2.1	20
S5010Y...				CC					
S5020S...	SH RED	660/643	20	CA	1.8	4.5	10	1.8	20
S5010S...				CC					
S5029Q...	SUPER RED	656/640	20	CA	2.2	5.5	10	2.1	20
S5019Q...				CC					
S5020T...	SUPER GREEN	573/571	15	CA	4.0	10.0	10	2.1	20
S5010T...				CC					
S5029C...	SUPER YELLOW	591/589	15	CA	4.0	10.0	10	2.1	20
S5019C...				CC					

Notes : The component is available in :

- Low Current
- InGaN high intensity blue, blue-green, green, white are available